

角の大きさ2

(三角形の作図)

年 組 名前()

次の図のような三角形をかきましょう。

(1)

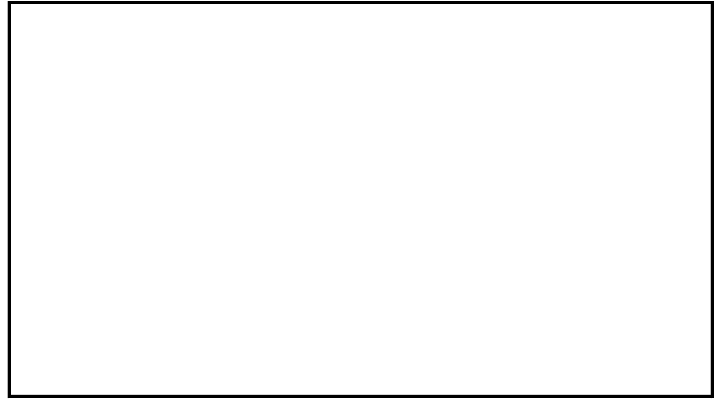
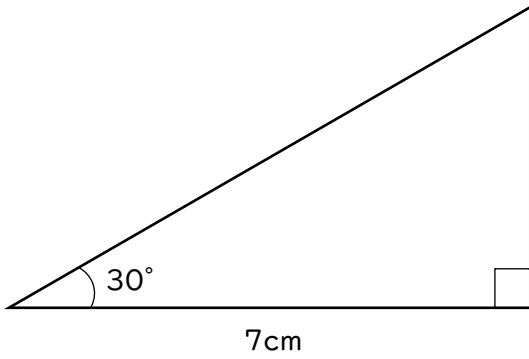

(2)

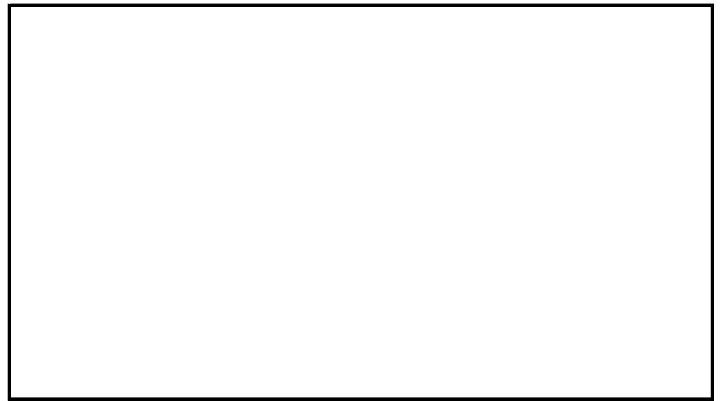
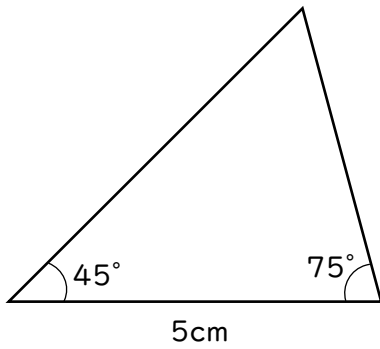

(3)

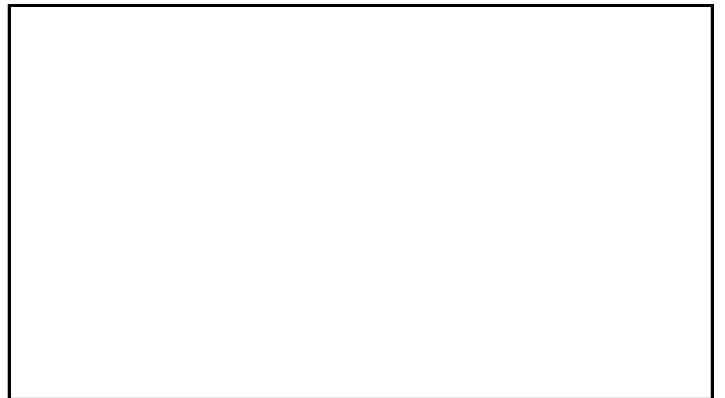
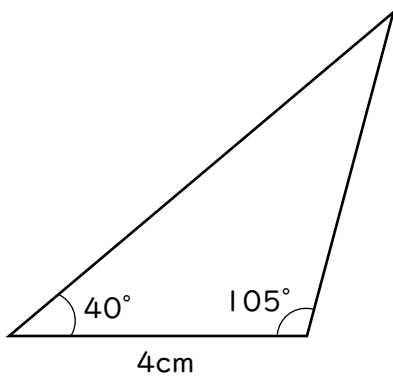

(4)

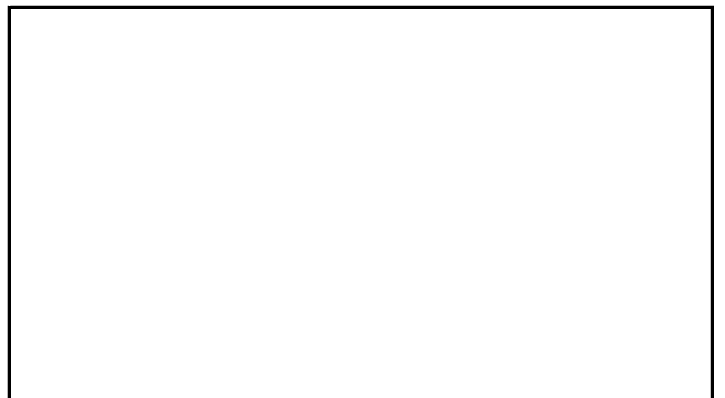
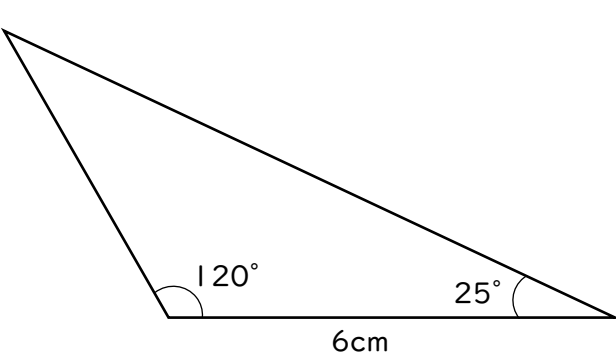

角の大きさ2

(三角形の作図)

年 組 名前()

次の図のような三角形をかきましょう。

(1)

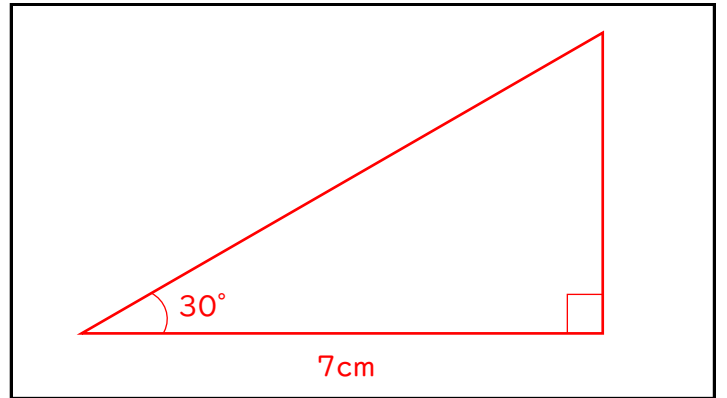
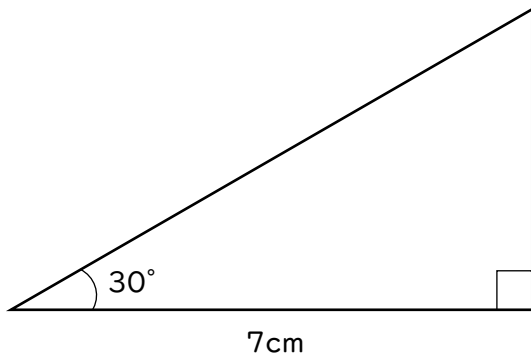

(2)

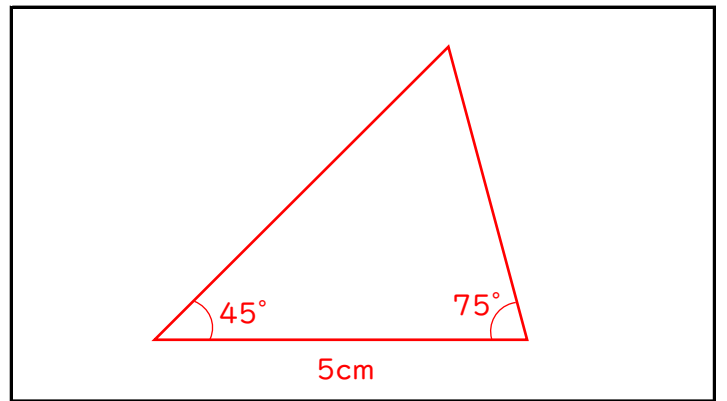
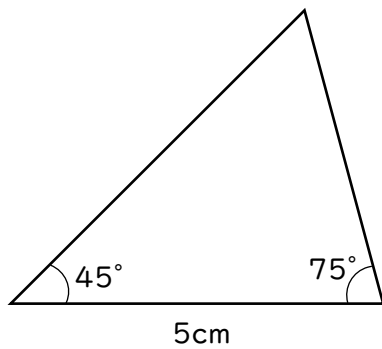

(3)

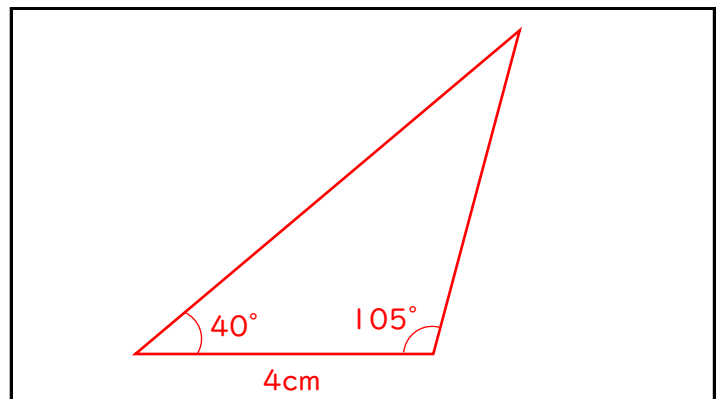
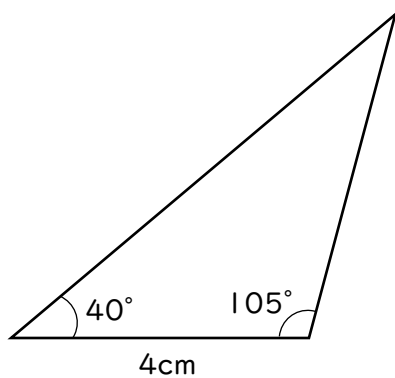

(4)

