

合同な図形 I

(合同な図形さがし)

年 組 名前 ()

次の図形のうち、アと合同な図形はどれですか。

(1)

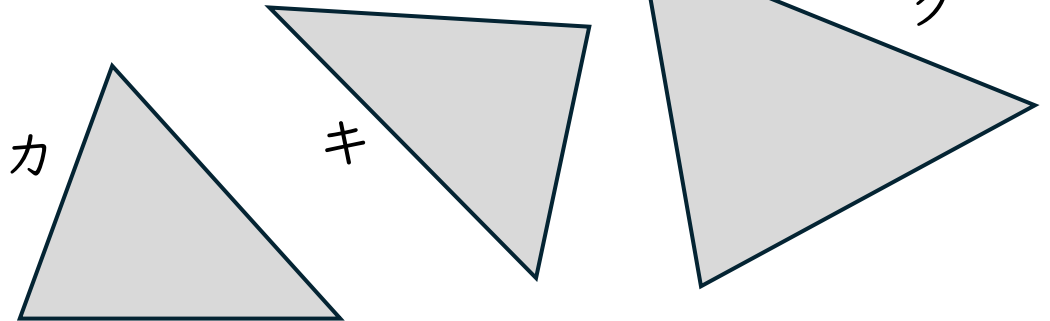
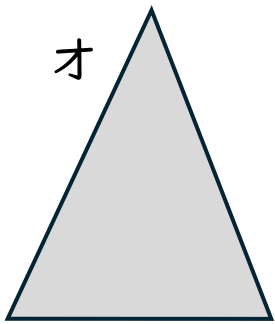
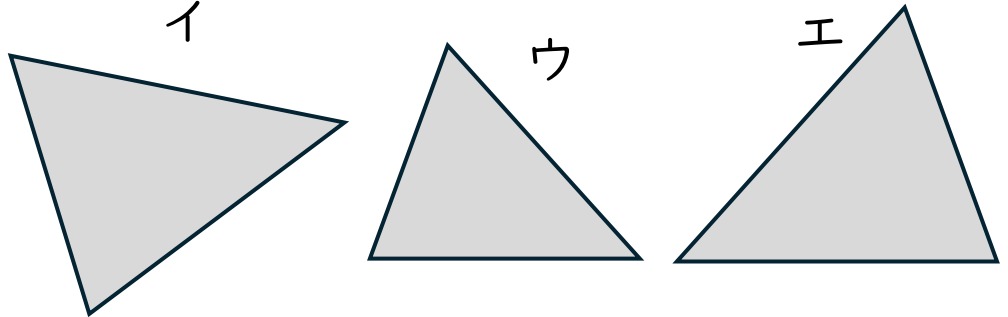
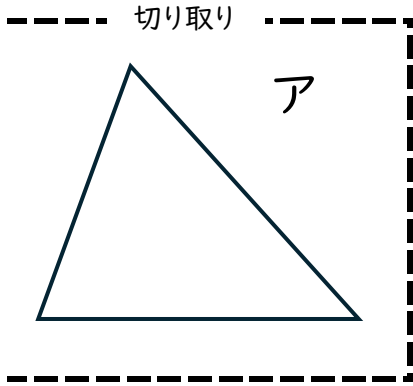

()

(2)

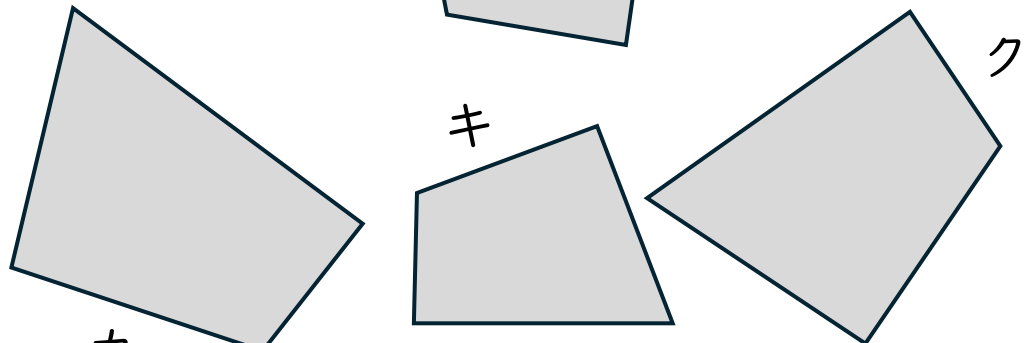
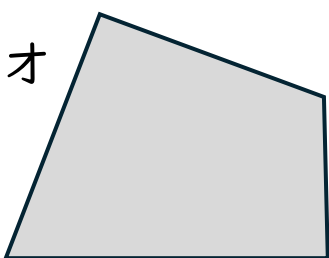
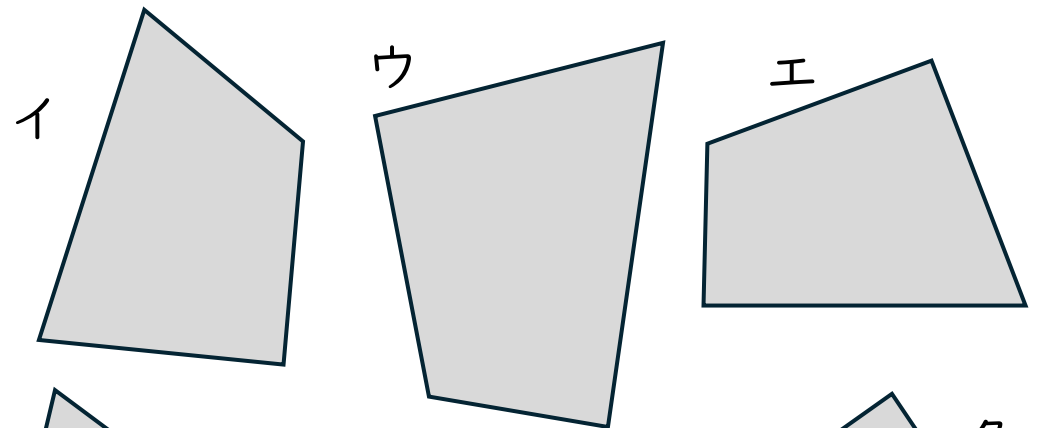
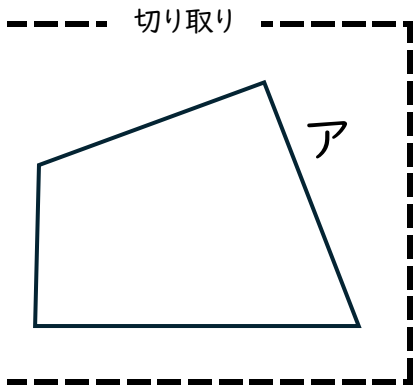

()

合同な図形 I

(合同な図形さがし)

年 組 名前 ()

次の図形のうち、アと合同な図形はどれですか。

(1)

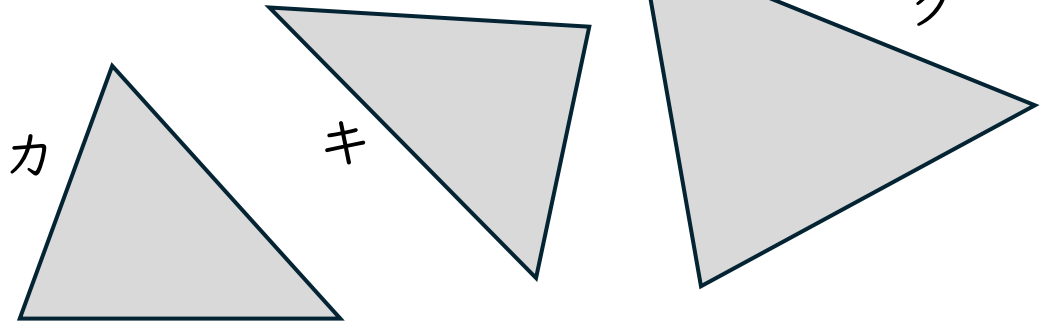
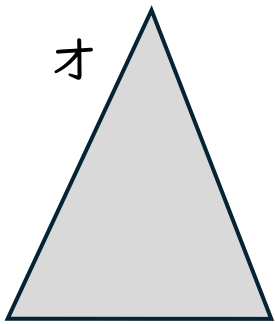
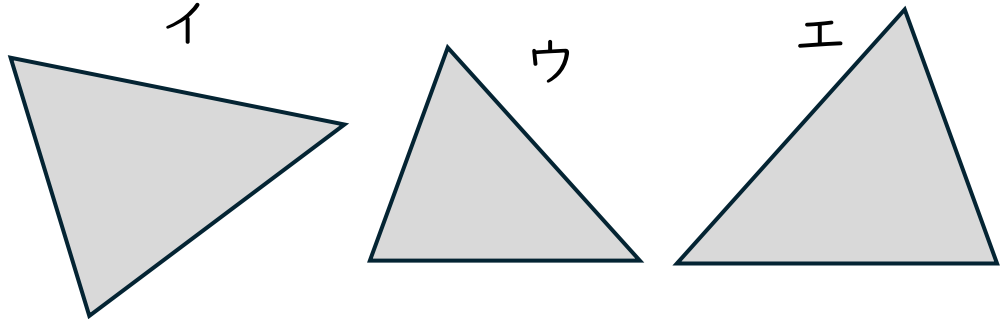
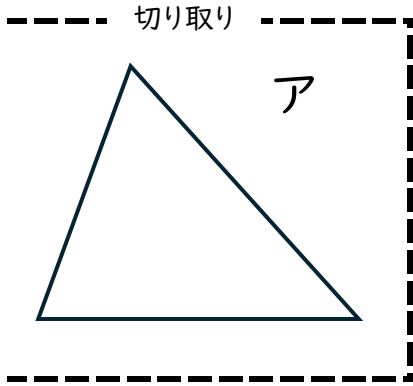

(**イ, エ, オ, カ**)

(2)

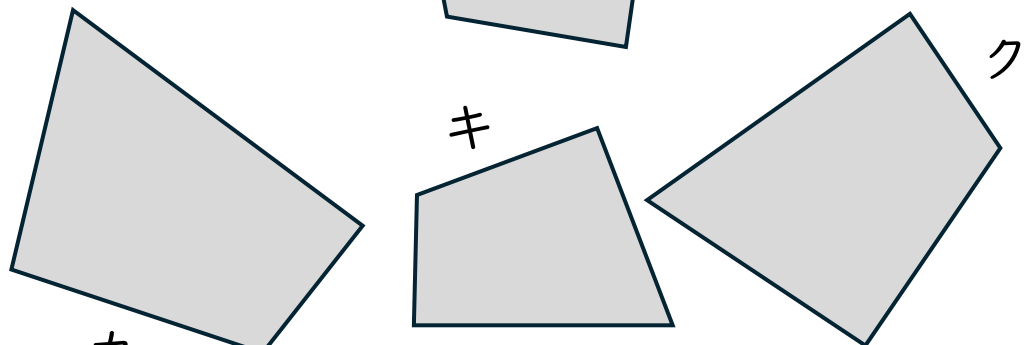
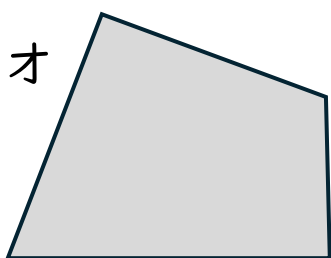
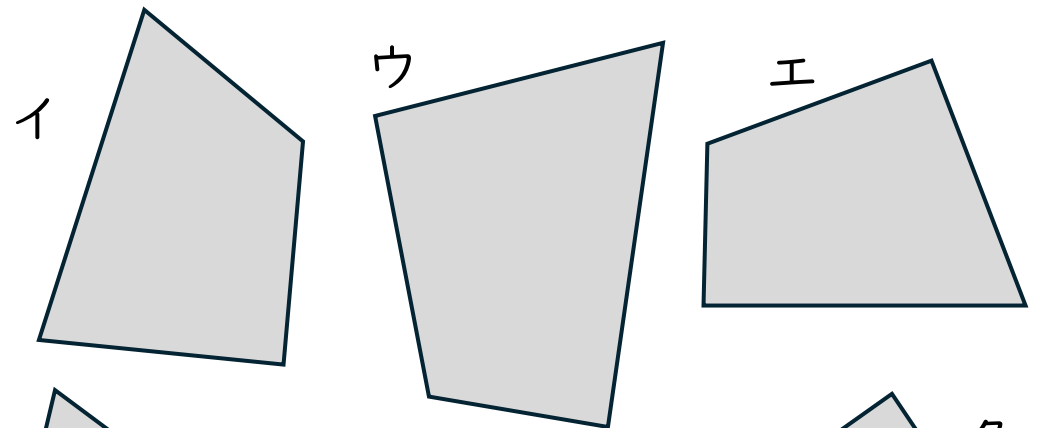
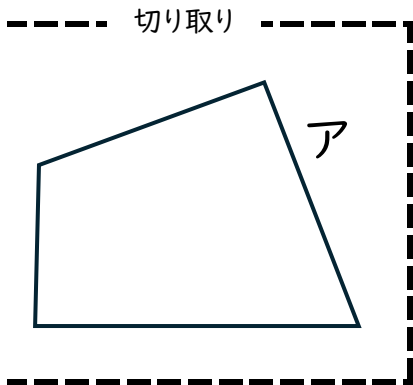

(**エ, オ, ク**)